

Force Balanced EX-TEND; Series 2212FOB, 12 inch Expansion Joint with Flange End Connections

Features and Applications:

- Nominal Pipe Sizes 4 inch through 12 inch Rated at 350 PSI
- For Ductile Iron, Steel (carbon), C900 PVC or HDPE pipes
- **Expansion unit will NOT impart a thrust force while under hydrostatic pressure**
- Designed to give Expansion/Contraction needs to protect pipeline systems from linear movement.
- Constructed of ASTM A536 Ductile Iron
- 8 inches of linear travel
- Each unit tested to rated working pressure prior to shipment
- Due to the design of the seals, no periodic maintenance is required
- End connections:
Flange; 4 inch through 12 inch
Mechanical Joint; 4 inch through 12 inch
- Flange outlets conform to the dimensional requirements of ANSI/AWWA C110/A21.10 (class 150) with the addition of an O-ring gasket which is provided to ensure a watertight seal
- Mechanical Joint end connections conform to the dimensional requirements of either ANSI/AWWA C111/A21.11 or ANSI/AWWA C153/A21.53 depending on size.
- EX-TEND assemblies are suitable for direct burial. Polyethylene wrap is provided with each unit. If installed in a vault, the design must be such that movement is not impeded. Refer to *Connections FT-2* found at www.ebaa.com.
- NOT for use on pipelines containing solids or debris.

For use on water pipelines subject to hydrostatic pressure and tested in accordance with either AWWA C600, C605, or ASTM D2774.

Sample Specification

1. Expansion joints shall be installed in the locations indicated on the drawings and shall be manufactured of ductile iron conforming to the material requirements of ASTM A536 and ANSI/AWWA C153/A21.53. Foundry certification of material shall be readily available upon request.
2. Each expansion joint shall be pressure tested prior to shipment against its own restraint to a minimum of 350 PSI for 4-inch through 12-inch. A minimum 2:1 safety factor, determined from the published pressure rating, shall apply.
3. Each expansion joint shall have 8-inches minimum expansion. The expansion fitting shall not expand or exert an axial imparting thrust under internal water pressure. The expansion fitting shall not increase or decrease the internal water volume as the unit expands or contracts.
4. All internal surfaces (wetted parts) shall be lined with a minimum of 15 mils of fusion bonded epoxy conforming to the applicable requirements of ANSI/AWWA C213. Sealing gaskets shall be constructed of EPDM. The coating shall meet ANSI/NSF-61.
5. Exterior surfaces shall be coated with a minimum of 6 mils of fusion bonded epoxy conforming to the applicable requirements of ANSI/AWWA C116/A21.16.
6. Polyethylene sleeves, meeting ANSI/AWWA C105/A21.5, shall be included for direct buried applications.
7. Manufacturer's certification of compliance to the above standards and requirements shall be readily available upon request. The purchaser (or owner) shall reserve the right to inspect the manufacturer's facility for compliance. All expansion joints shall be The Force Balanced EX-TEND as manufactured by EBAA Iron, Inc. Eastland, TX., U.S.A.

This Sample Specification is available as a Microsoft® Word Document at www.ebaa.com/products/flex.

EX-TEND Force Balanced Submittal Drawing

EBAA IRON

MADE IN USA

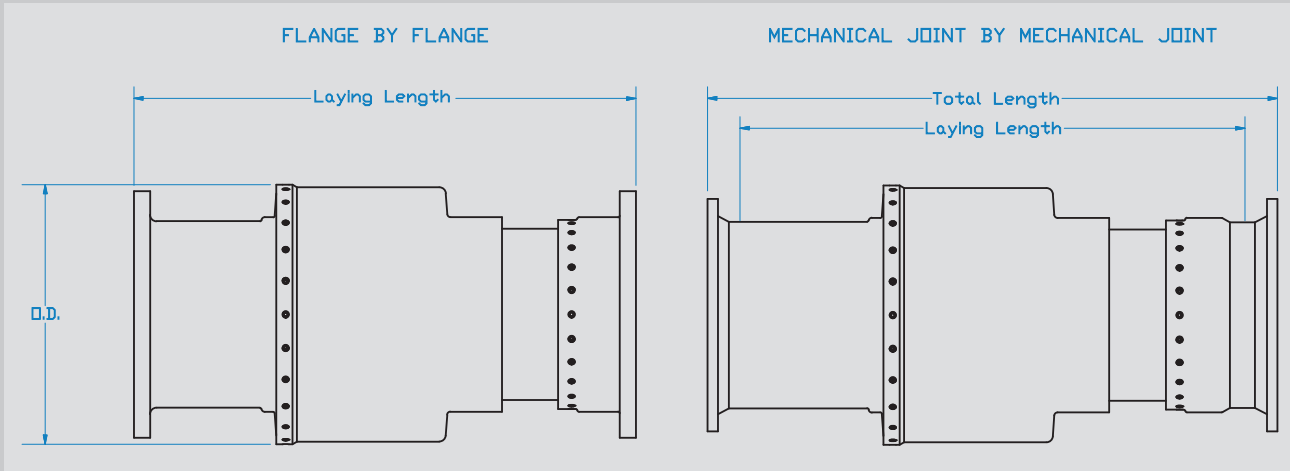

Nominal Pipe Size	Expansion* (Linear)	Maximum O.D.	Flange by Flange			Mechanical Joint by Mechanical Joint		
			Assembly Number	Laying Length	Total Length	Assembly Number	Laying Length	Total Length
4	8.00	10.2	4204F0B	34.25 (±4.0)	34.25 (±4.0)	4204M0B	34.38 (±4.0)	39.40 (±4.0)
6	8.00	12.3	4206F0B	36.30 (±4.0)	36.30 (±4.0)	4206M0B	34.49 (±4.0)	39.53 (±4.0)
8	8.00	14.9	4208F0B	39.00 (±4.0)	39.00 (±4.0)	4208M0B	37.11 (±4.0)	42.11 (±4.0)
10	8.00	18.1	4210F0B	10.11 (±4.0)	10.11 (±4.0)	4210M0B	37.71 (±4.0)	43.74 (±4.0)
12	8.00	20.8	4212F0B	38.68 (±4.0)	38.68 (±4.0)	4212M0B	38.82 (±4.0)	43.90 (±4.0)

NOTE: Dimensions are in inches, and are subject to change without notice.

*Maximum travel, units are set to a +50%/-50% configuration.

End connection combinations available, including grooved.

FLEX-TEND®, EX-TEND®, AND FLEX-900® FLANGE O-ring Groove

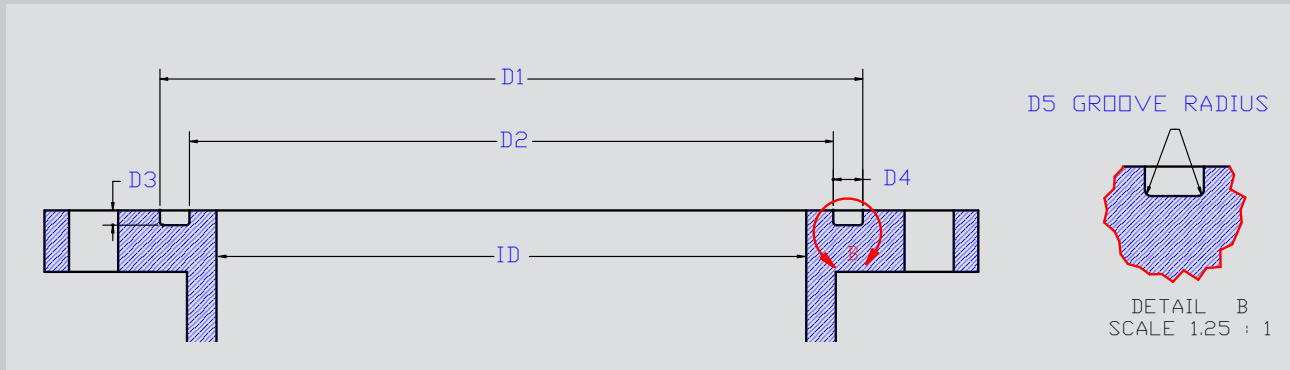

Size	D1	D2	D3	D4	D5	O-ring Diameter	O-ring Part Number
4	5.900	4.700	0.300	0.600	0.0625	0.5	983004
6	8.00	6.800	0.300	0.600	0.0625	0.5	983006
8	10.100	8.900	0.300	0.600	0.0625	0.5	983008
10	12.200	11.000	0.300	0.600	0.0625	0.5	983010
12	14.300	13.100	0.300	0.600	0.0625	0.5	983012

EBAA IRON Sales, Inc.

P.O. Box 857, Eastland, TX 76448

Tel: (254) 629-1731

Fax: (254) 629-8931

(800) 433-1716 within US and Canada

contact@ebaa.com

www.ebaa.com

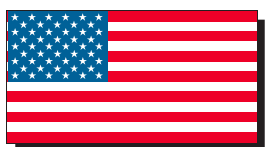

MADE IN USA

Members of...

