



Series 261200DSS16

Restraint for C900 or C909 PVC Pipe At PVC Fittings

CONTAINS ALL DOMESTIC HARDWARE

Installation Instructions

1. The Series 2600 is designed for restraining C900 or C909 PVC pipe at PVC fittings. The restraint has a split, serrated restraint ring on the plain end or spigot end of the pipe and a split, non-serrated ring on the PVC fitting.
2. Assemble joint per the pipe and fitting manufacturer's instructions
3. Install both halves of the split non-serrated bell ring on the fitting behind the gasket hump. Install the side bolts and tighten each to 110 ft-lbs. (60 ft-lbs on 4" and 6")
4. Slide the bell ring toward the gasket hump so that it fits snugly behind the gasket hump.
5. Remove the side bolts from the split serrated restraint ring. Use the provided thrust bolts to determine the proper location of the restraint ring on the spigot end of the PVC pipe.
6. Install both halves of the restraint ring at the proper location, tapping each half into place. Make sure that the complete ID of the ring is touching the pipe before installing the side bolts. Tighten the side bolts evenly to 120 ft-lbs. (70 ft-lbs on 4" and 6")
7. Place nuts on thrust bolts and hand tighten until they are snug. Allow enough room on the thrust bolts to fully engage the nuts.

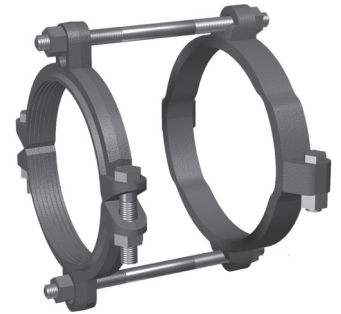

CONTENTS

Qty.	Description
1	1912RR
1	2512BR
2	3/4 in. by 18 in. Stainless Steel Thrust Rods w/ Nuts

Restraints Made in The USA

Do not tighten thrust bolts enough to force the spigot end of the PVC pipe further into the bell of the joint.

For use on water or wastewater pipelines subject to hydrostatic pressure and tested in accordance with either AWWA C600 or ASTM D2774

APPROXIMATE SHIPPING WEIGHT: 61.29 lbs.

0120-B

Copyright 2021 © EBAA IRON, Inc. All Rights Reserved

Series 261200DSS16

Restraint for C900 or C909 PVC Pipe At PVC Fittings

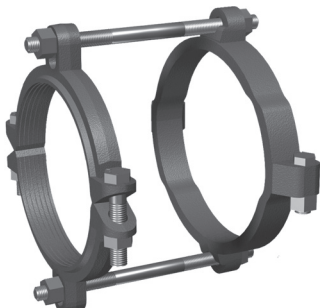

2 6 1 2 0 0 D S S 1 6

EBAA IRON SALES, Inc.
P.O. Box 857, Eastland, TX 76448
Tel: (254) 629-1731
Fax: (254) 629-8931
Toll: (800) 433-1716
contact@ebaa.com
www.ebaa.com

Made in the USA