



Series 250600DSS4

Restraint for C900 PVC Pipe at PVC Fittings

CONTAINS ALL DOMESTIC HARDWARE

Installation Instructions

1. The Series 2500 is designed for restraining AWWA C900 PVC pipe to molded or fabricated fittings. It has a split, serrated restraint ring on the spigot and a split non-serrated ring on the fitting.
2. Assemble the fitting per the fitting manufacturer's instructions.
3. Install both halves of the split non-serrated bell ring on the fitting behind the gasket hump. Install the side bolts and tighten each to 110 ft.-lbs. (60 ft.-lbs. on 4" and 6".)
4. Slide the bell ring toward the gasket hump so that it fits snugly behind the gasket hump.
5. Remove the side bolts from the serrated restraint ring. Use the tie bolts to determine the proper location of the restraint ring on spigot. Allow enough room on tie bolt to fully engage the nuts.
6. Install both halves of the restraint ring at the proper location, tapping each half into place. Make sure that the complete ID of the ring is touching the pipe before installing the side bolts. Tighten the side bolts evenly to 110 ft.-lbs. (60 ft.-lbs. on 4" and 6".)
7. Place nuts on the tie bolts and tighten until they are snug. Allow enough room on the tie bolt to fully engage the nut with several threads showing. Do not tighten these bolts enough to force the spigot further into the bell of the fitting.

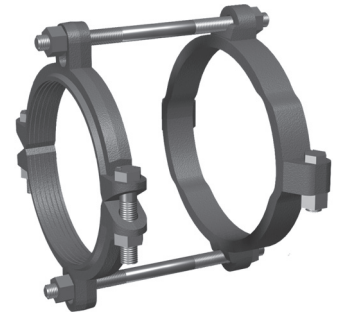

CONTENTS

Qty.	Description
1	6 inch 1500 Split Restraint Ring
1	6 inch 2500 Split Back Up Ring
2	Stainless Steel Tie Rods w/ Nut

Restraints Made in The USA

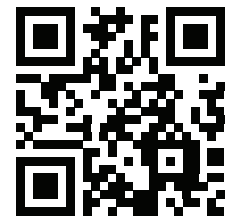

For use on water or wastewater pipelines subject to hydrostatic pressure and tested in accordance with either AWWA C600 or ASTM D2774

APPROXIMATE SHIPPING WEIGHT: 20.5 lbs.

0221-J

Copyright 2021 © EBAA IRON, Inc. All Rights Reserved

Series 250600DSS4

Restraint for C900 PVC Pipe at PVC Fittings

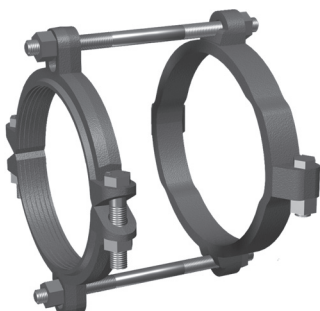

2 5 0 6 0 0 D S S 4

EBAA IRON SALES, Inc.

P.O. Box 857, Eastland, TX 76448

Tel: (254) 629-1731

Fax: (254) 629-8931

Toll: (800) 433-1716

contact@ebaa.com

www.ebaa.com

Made in the USA