



Tru-Dual® Series 15PF10TD

Restraint for C900 PVC
Pipe at Ductile Iron Fittings

Installation Instructions

1. Identify the Pipe. The Series 15PF00TD is designed for restraining C900 PVC pipe or Ductile Iron pipe at ductile iron fittings supplied with restraining ears. It has a split; serrated restraint ring with Tru-Dual® inserts on the spigot and attaches to the joint with connecting rods.
2. Assemble joint per the pipe manufacturer's instructions.
3. Using the connecting rods to determine the proper restraint location, install both halves of the restraint by tapping them into place. Allow enough room on the connecting rods to fully engage the nuts. Make sure the complete I.D. of the restraint is touching the pipe before installing and tightening of side bolts. Side bolts are to be evenly tightened to 60 ft-lbs of torque (110 ftlbs on 8 inch, 10 inch, and 12 inch).
4. Tighten the connecting bolts until snug. Do not over tighten connecting bolts as to move the spigot further into the joint.

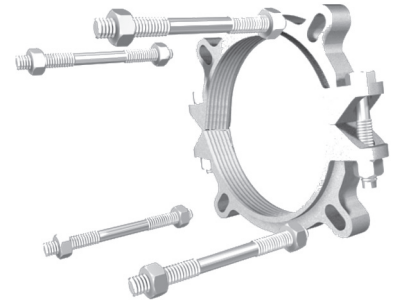

CONTENTS

Qty.	Description
1	10 in. 1500TD Split Restraint Ring
2	Low Alloy Steel Tie Rods w/ Nuts

Restraints Made in The USA

1113-E

For use on water or wastewater pipelines subject to hydrostatic pressure and tested in accordance with either AWWA C600 or ASTM D2774

APPROXIMATE SHIPPING WEIGHT: 33 lbs.

Copyright 2021 © EBAA IRON, Inc. All Rights Reserved

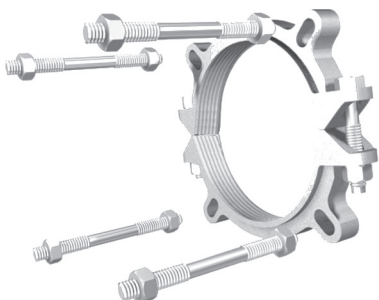

Series 15PF10TD

Restraint for C900 PVC
Pipe at Ductile Iron Fittings



1 5 P F 1 0 T D

EBAA IRON SALES, Inc.

P.O. Box 857, Eastland, TX 76448

Tel: (254) 629-1731

Fax: (254) 629-8931

Toll: (800) 433-1716

contact@ebaa.com

www.ebaa.com

Made in the USA